

Geländerelemente aus Gusseisen, montagefertig

*W. Drab[®]
Alt-Wiener Guswaren*

CAST-IRON ELEMENT FOR RAILING

Suitable for fences and balconies installation

Complete panels ready for mounting.



Compliance

Compliant with UNI 10803 - 10809 standards.

Protection against corrosion

Protection against corrosion is obtained with a technological cycle of sandblasting, one coat of one-part zinc primer; one coat of two-part zinc phosphate primer, one immersion coat of alkyd resin primer, and two finishing coats of two-pack paint

Panel structure

Elements with central decorations, made entirely from grey lamellar cast iron compliant with UNI EN-GJL-200 standards;

frame made in Fe 360 steel UNI EN 10219-1 hot-galvanized to UNI EN ISO 1461 standards:

- a U-profiled dim. 40 mm ("1.57) x 20 mm ("0.79) section mm.6 ("0.24) with Ø 14 ("0.55) holes at the bottom ; - a plate dim. 30 mm ("1.18) x 15 mm ("0.59). x with Ø 10 ("0.39) countersunk holes at the top ;
- a shaped handrail 50 mm ("1.97) x 15 mm ("0.59) resting on top plate.

The modular panel is supplied completely assembled and painted in grey standard color; different RAL colors on demand.

Geländerelement aus Gusseisen , montagefertig



Zubehör:

Geländersteher aus Stahl verzinkt und lackiert oder aus Gusseisen lackiert

Befestigungslaschen für 90 Grad oder 180 Grad G061+ G005 Zierabschlüsse für Geländersteher, G015

Montagewinkel für Mauerbefestigung

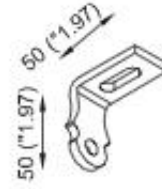
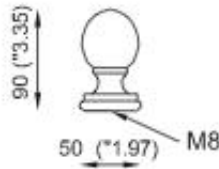
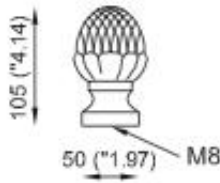

G061	G005	G015
------	------	------

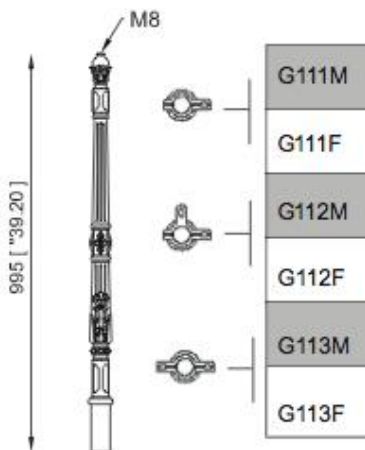
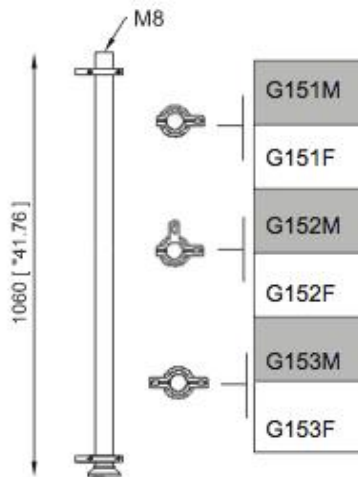
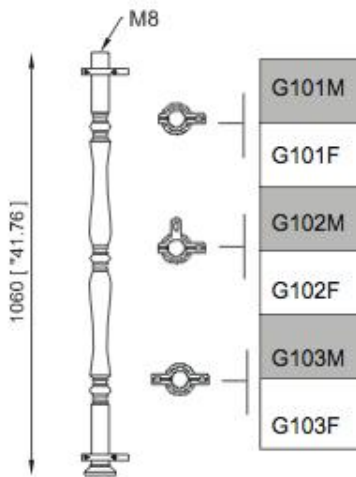

Geländerelement aus Gusseisen , montagefertig



Art.: MG503

Rahmenhöhe : 1010 mm

Benötigte Elemente per Laufmeter: 5 Stück

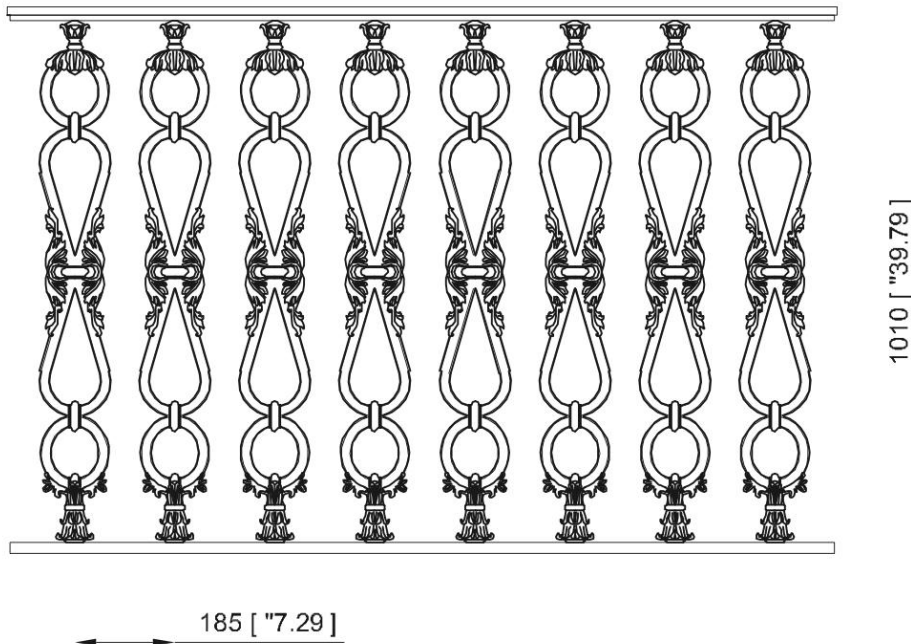

Geländerelement aus Gusseisen , montagefertig



Art.: MG510

Rahmenhöhe : 1010 mm

Benötigte Elemente per Laufmeter: 8 Stück

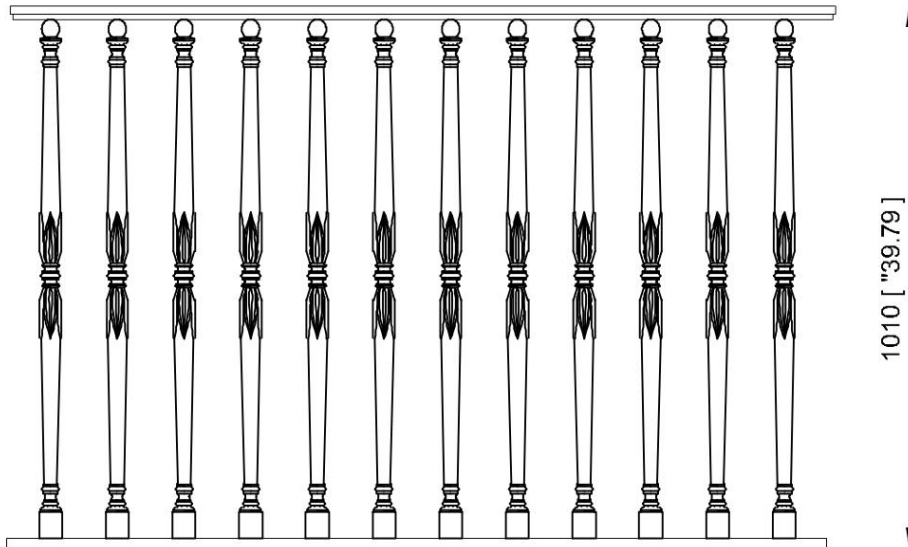

Geländerelement aus Gusseisen , montagefertig



Art.: MG514

Rahmenhöhe : 1010 mm

Benötigte Elemente per Laufmeter: 4 Stück

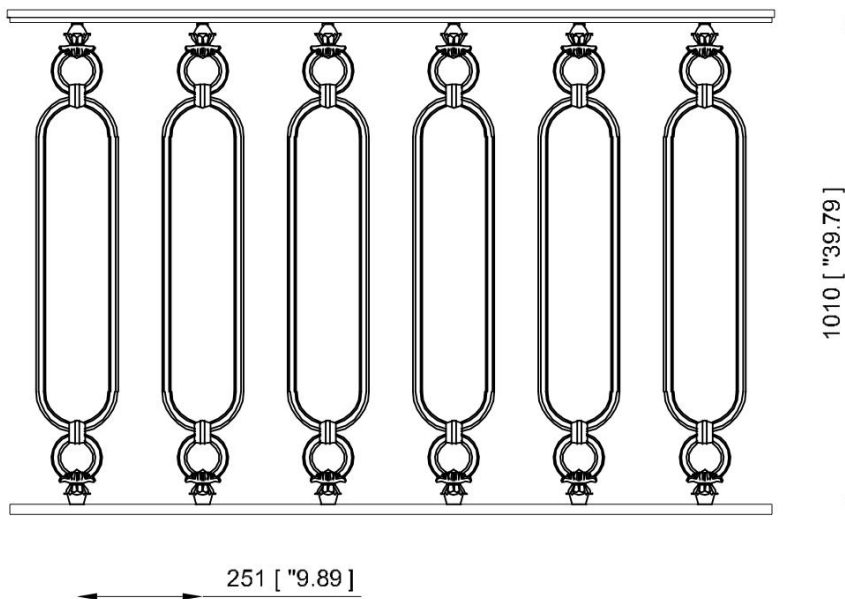

Geländerelement aus Gusseisen , montagefertig



Art.: MG515

Rahmenhöhe : 1010 mm

Benötigte Elemente per Laufmeter: 4 Stück

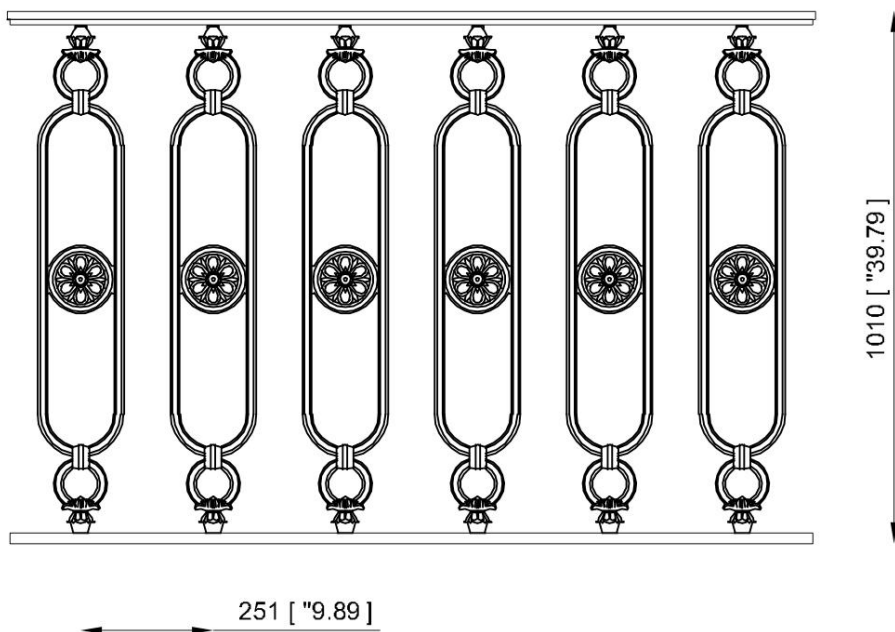

Geländerelement aus Gusseisen , montagefertig

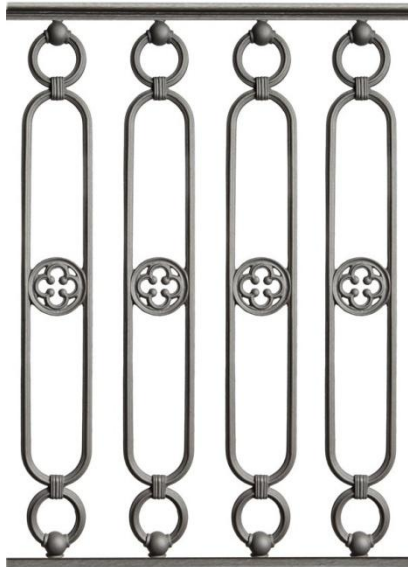

Art.: MG517

Rahmenhöhe : 1010 mm

Benötigte Elemente per Laufmeter: 5 Stück

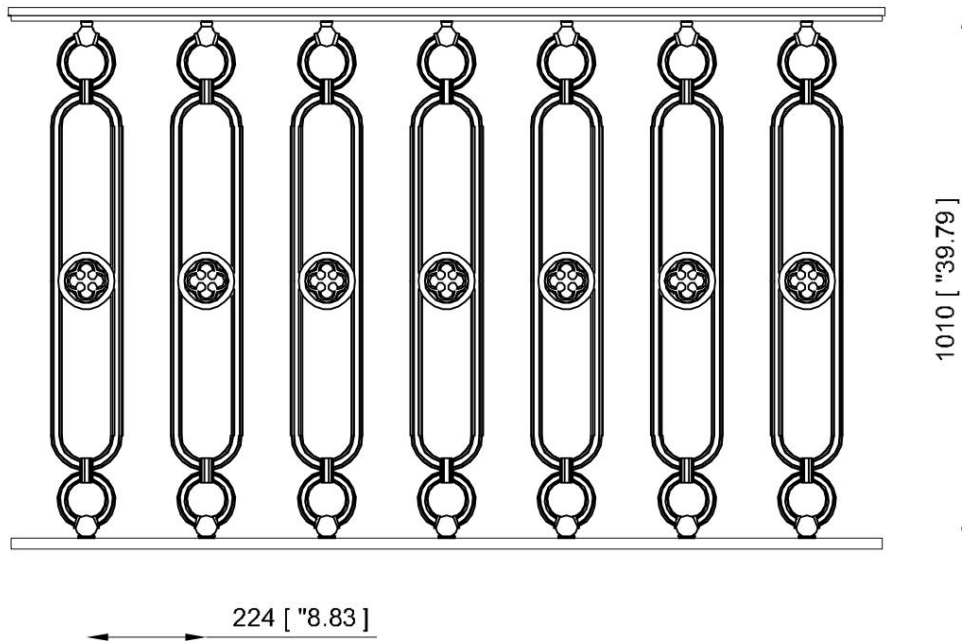

Geländerelement aus Gusseisen , montagefertig



Art.: MG518

Rahmenhöhe : 1010 mm

Benötigte Elemente per Laufmeter: 5 Stück

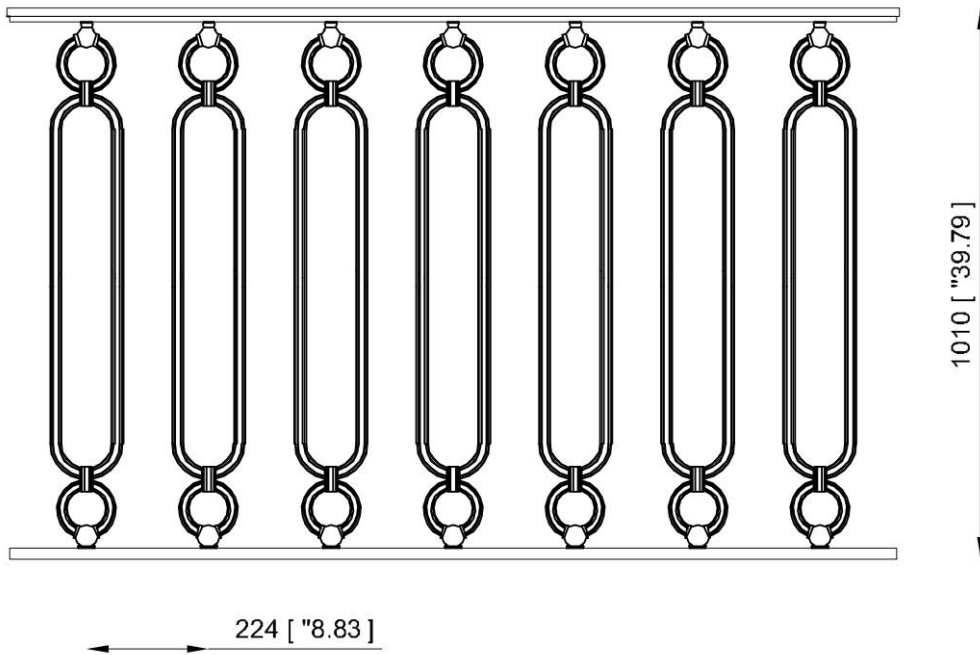

Geländerelement aus Gusseisen , montagefertig



Art.: MG523

Rahmenhöhe : 1010 mm

Benötigte Elemente per Laufmeter: 4 Stück

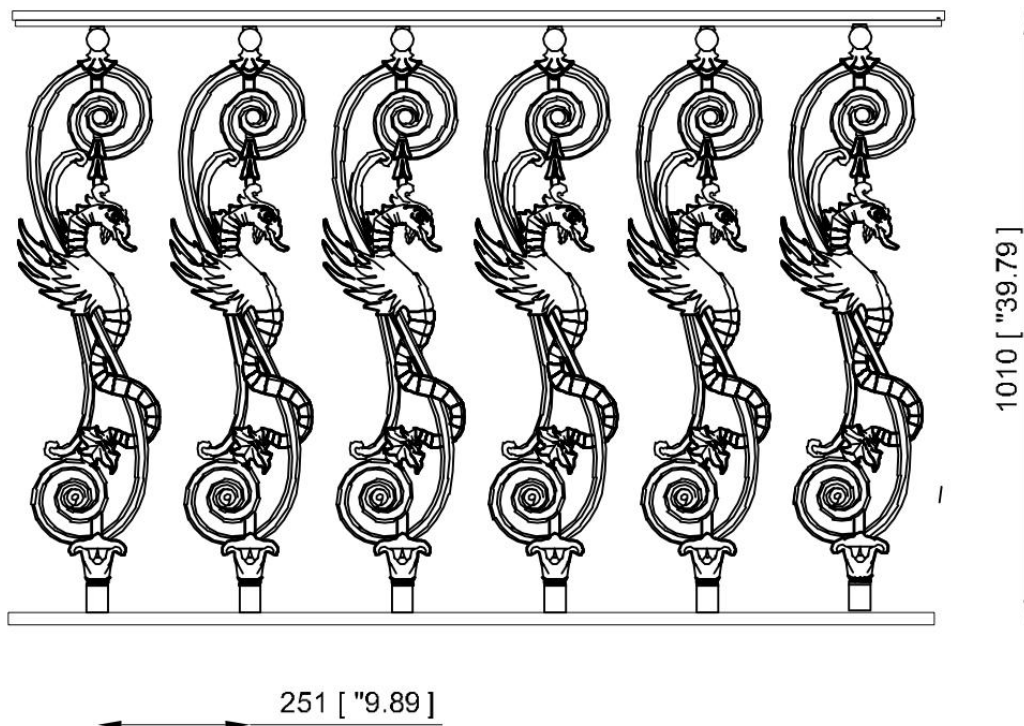

Geländerelement aus Gusseisen , montagefertig



Art.: MG525

Rahmenhöhe : 1010 mm

Benötigte Elemente per Laufmeter: 5 Stück

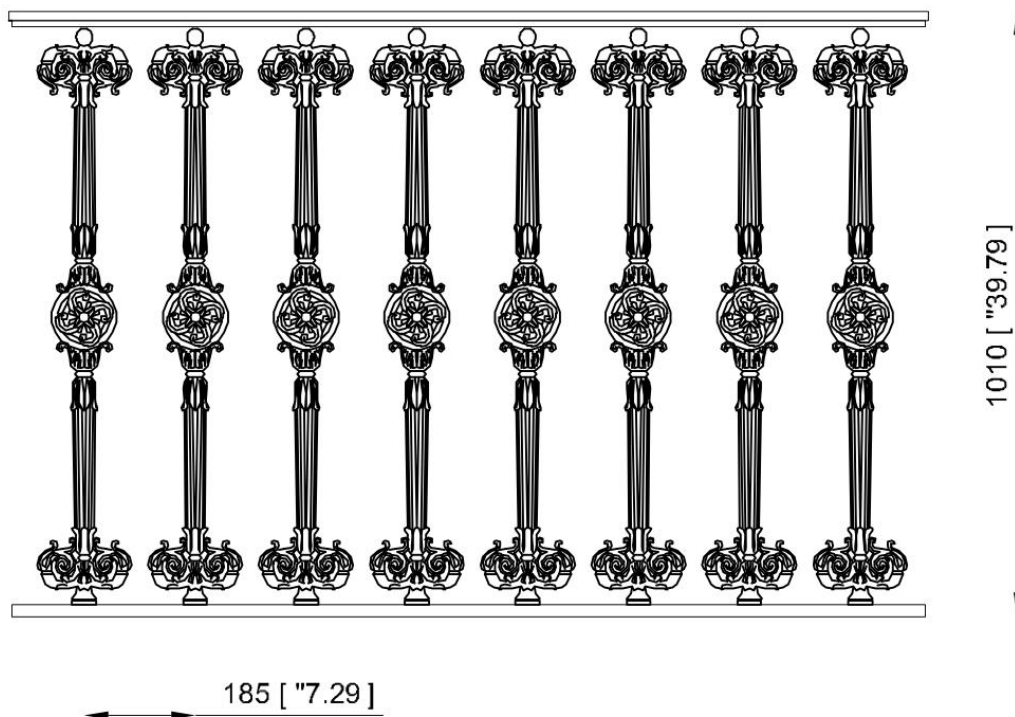

Geländerelement aus Gusseisen , montagefertig



Art.: MG530

Rahmenhöhe : 1010 mm

Benötigte Elemente per Laufmeter: 5 Stück

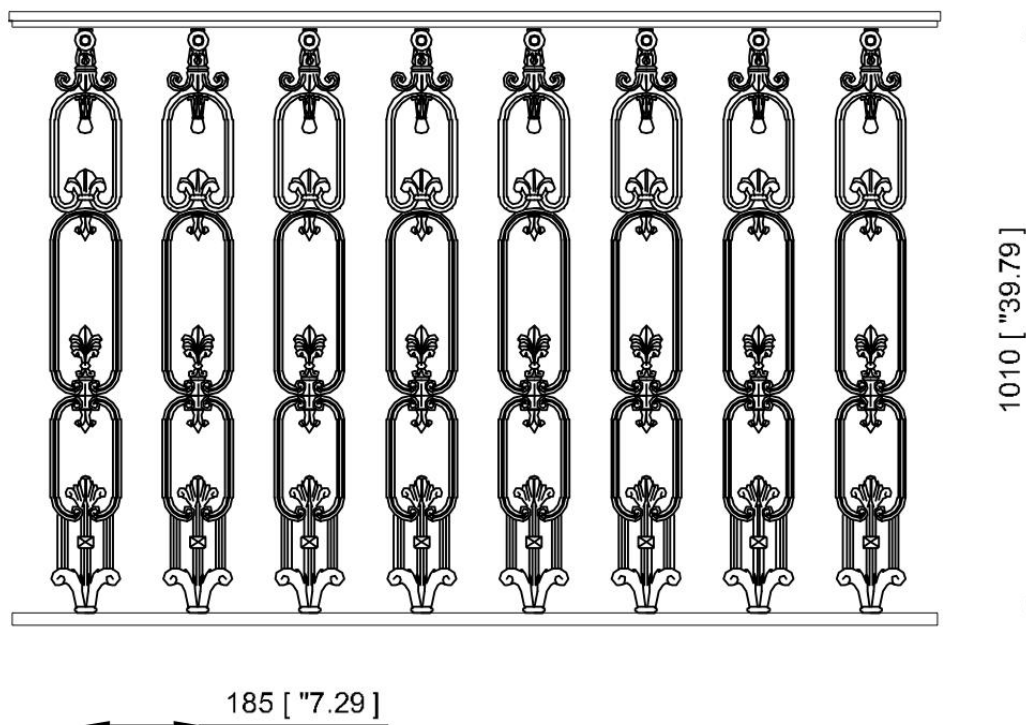

Geländerelement aus Gusseisen , montagefertig

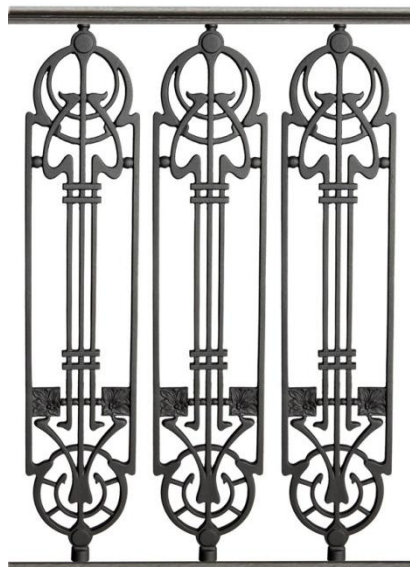

Art.: MG531

Rahmenhöhe : 1010 mm

Benötigte Elemente per Laufmeter: 4 Stück

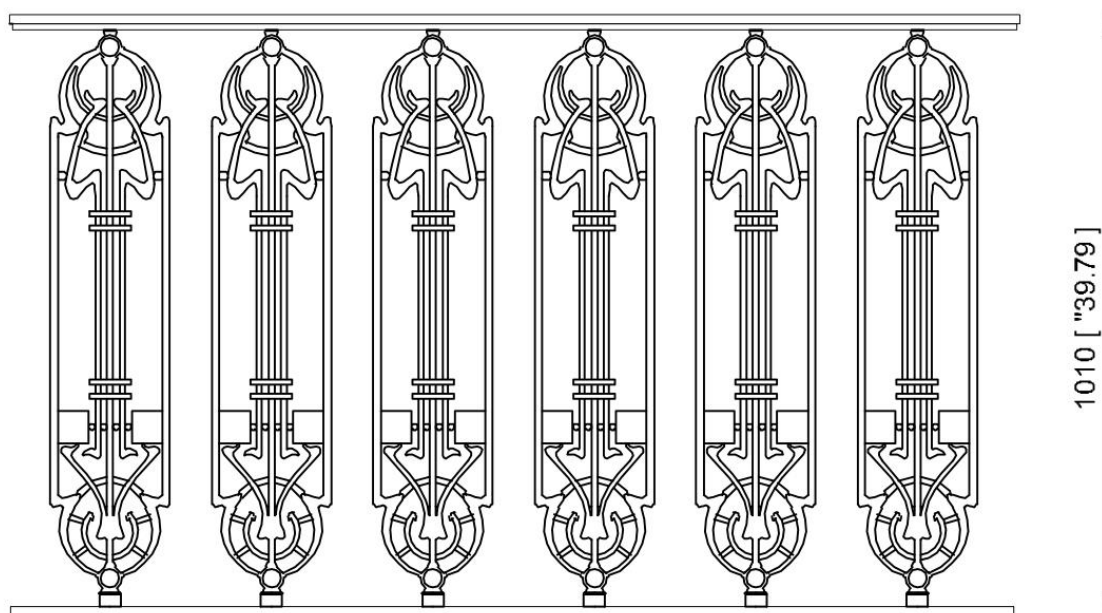

Geländerelement aus Gusseisen , montagefertig

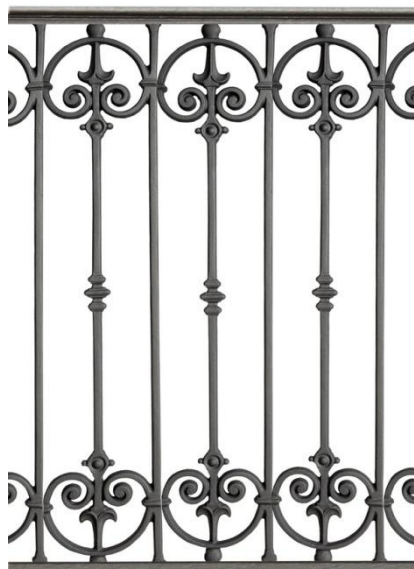

Art.: MG535

Rahmenhöhe : 1010 mm

Benötigte Elemente per Laufmeter: 5 Stück

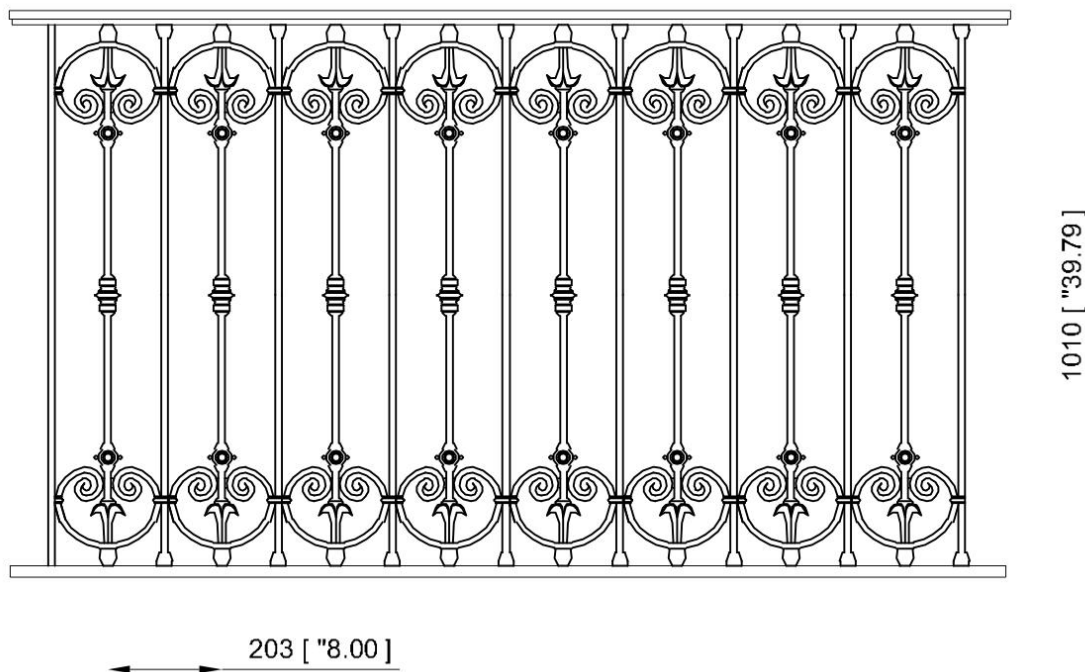

Geländerelement aus Gusseisen , montagefertig

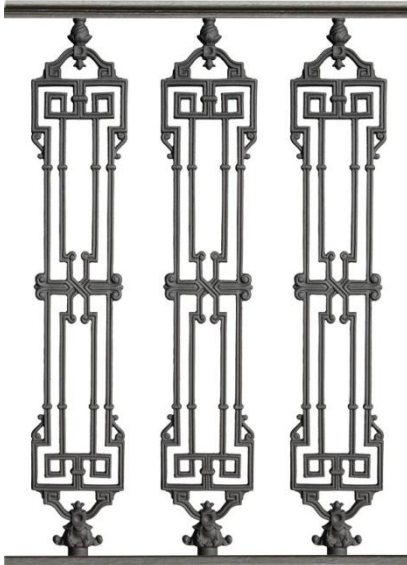

Art.: MG536

Rahmenhöhe : 1010 mm

Benötigte Elemente per Laufmeter: 4 Stück

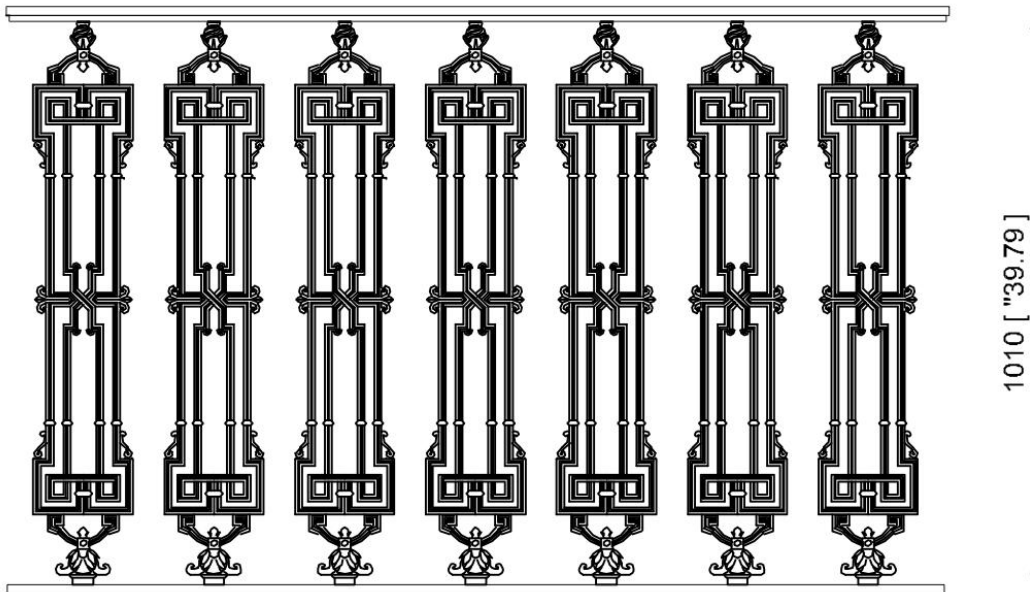

Geländerelement aus Gusseisen , montagefertig



Art.: MG542

Rahmenhöhe : 1010 mm

Benötigte Elemente per Laufmeter: 3 Stück

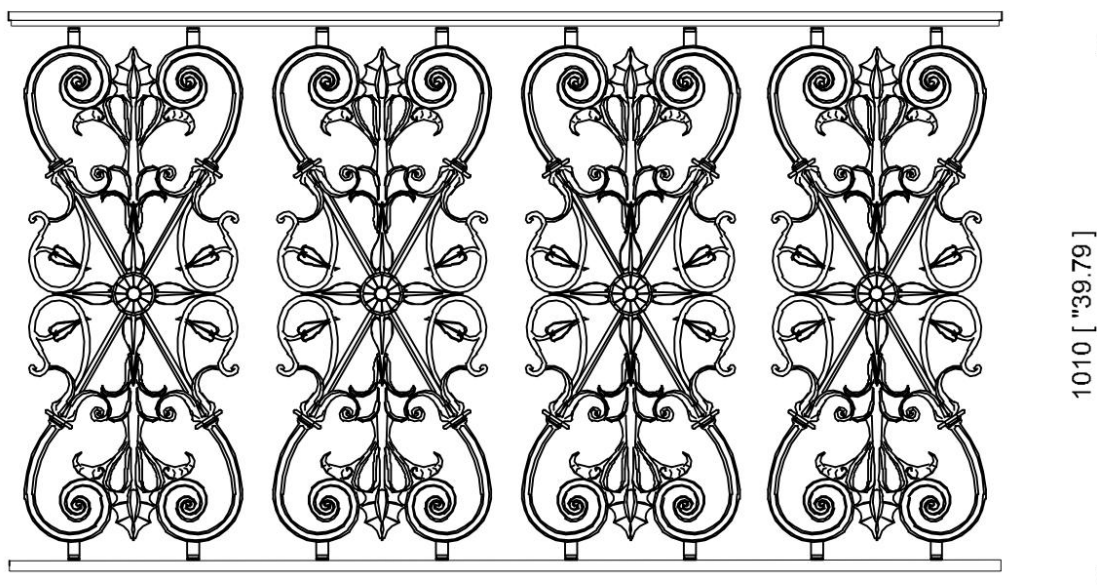

Geländerelement aus Gusseisen , montagefertig

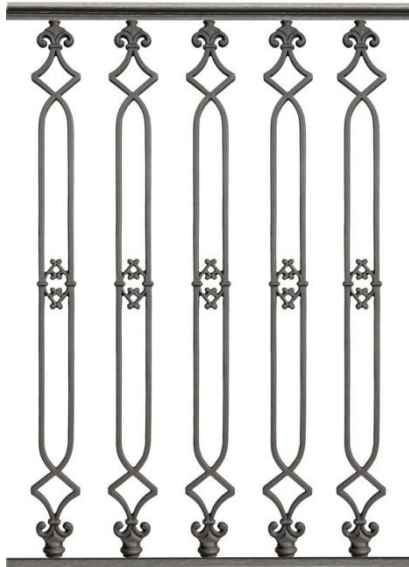

Art.: MG543

Rahmenhöhe : 1010 mm

Benötigte Elemente per Laufmeter: 6 Stück

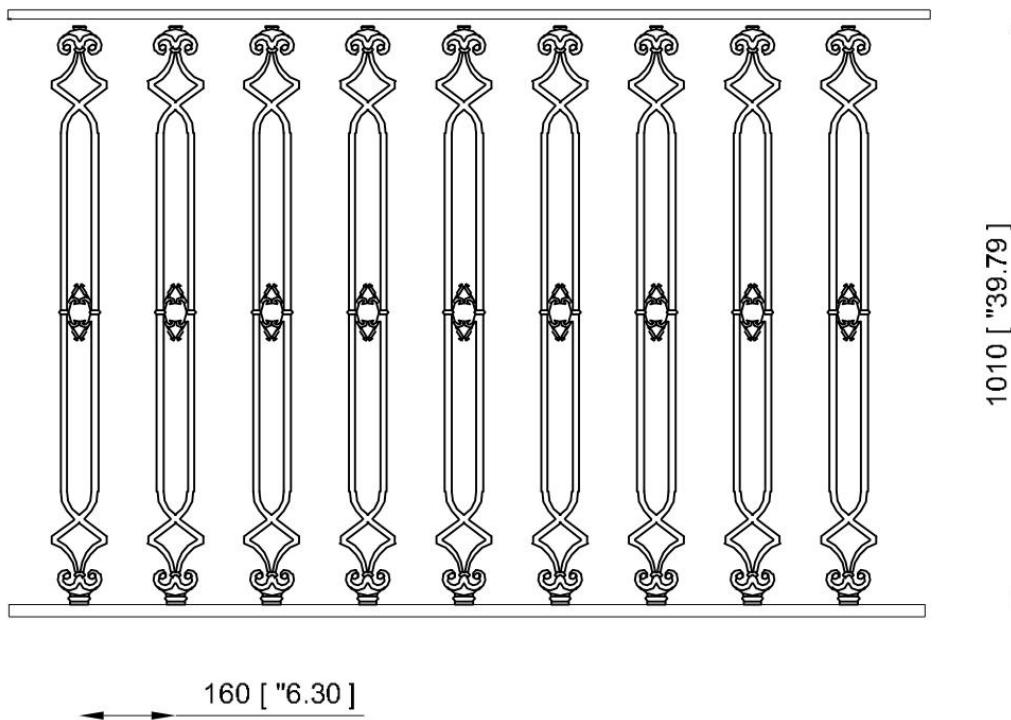

Geländerelement aus Gusseisen , montagefertig



Art.: MG544

Rahmenhöhe : 1010 mm

Benötigte Elemente per Laufmeter: 4 Stück

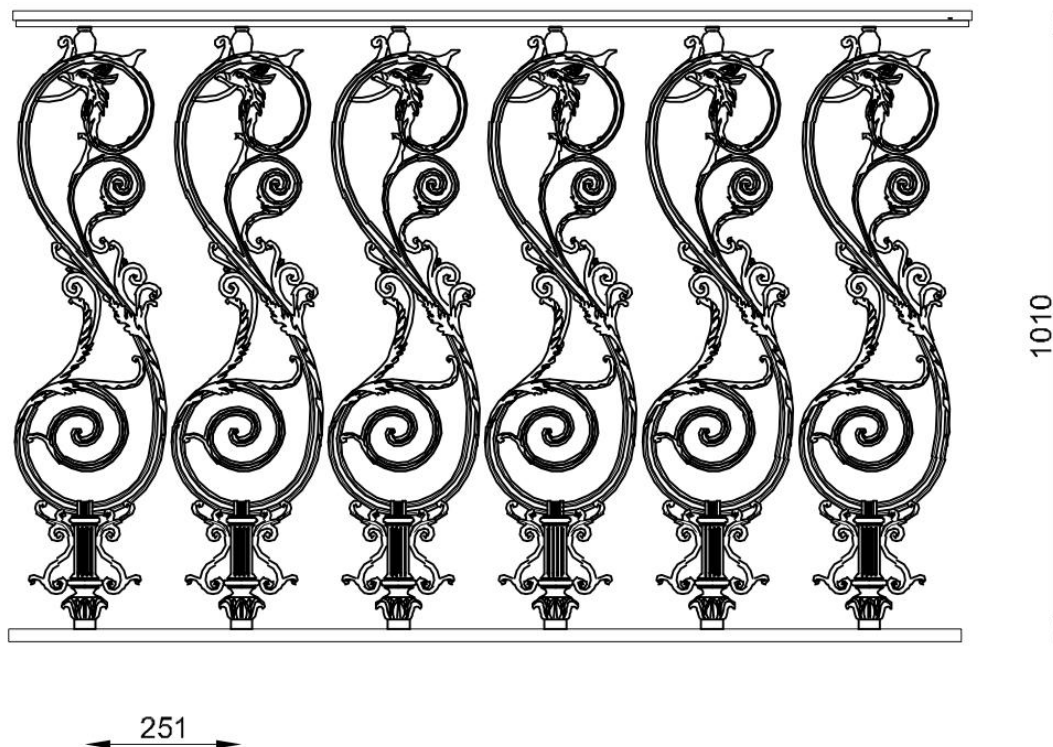

Geländerelement aus Gusseisen , montagefertig



Art.: MG 545

Rahmenhöhe : 1010 mm

Benötigte Elemente per Laufmeter: 5 Stück

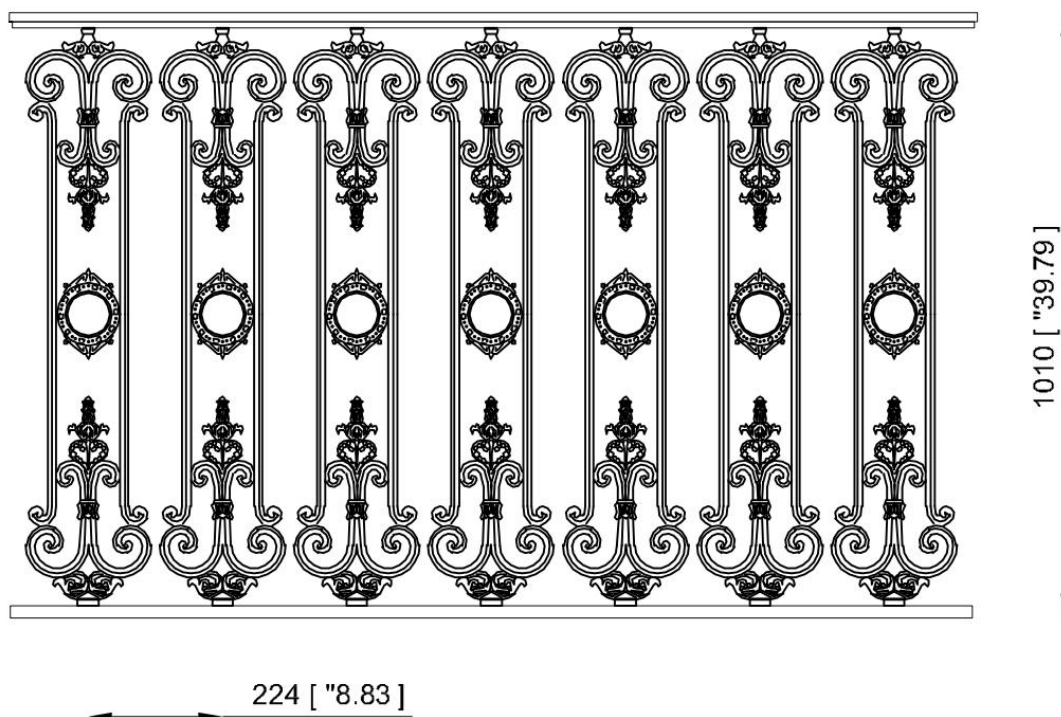

Geländerelement aus Gusseisen , montagefertig



Art.: MG546

Rahmenhöhe : 1010 mm

Benötigte Elemente per Laufmeter: 4 Stück

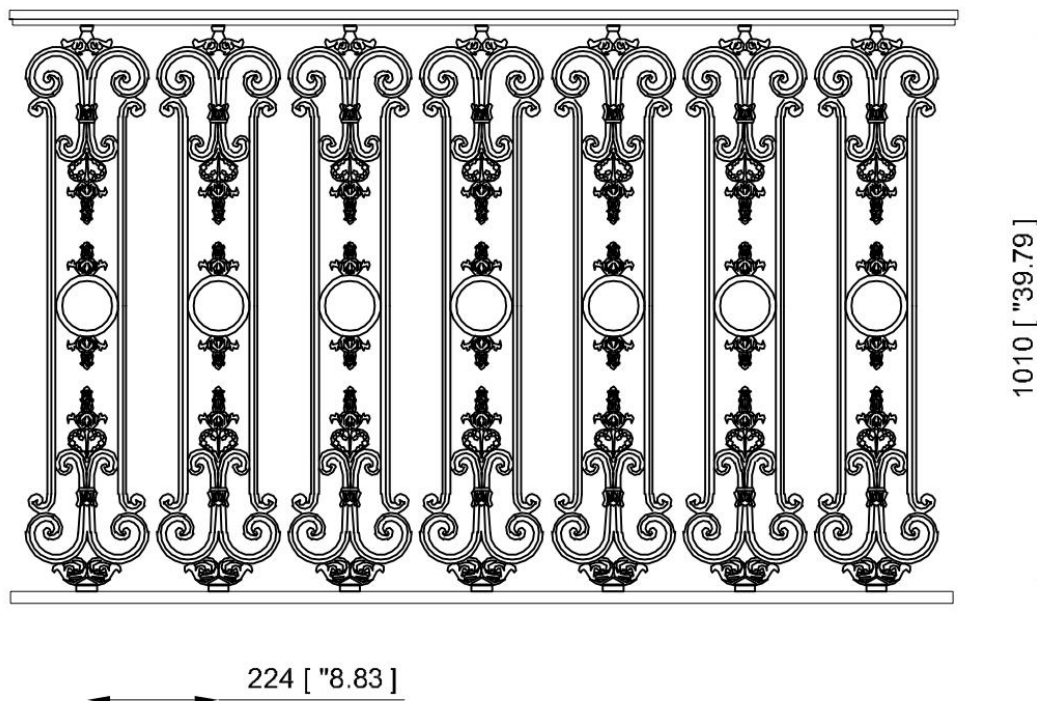

Geländerelement aus Gusseisen , montagefertig



Art.: MG547

Rahmenhöhe : 1010 mm

Benötigte Elemente per Laufmeter: 4 Stück

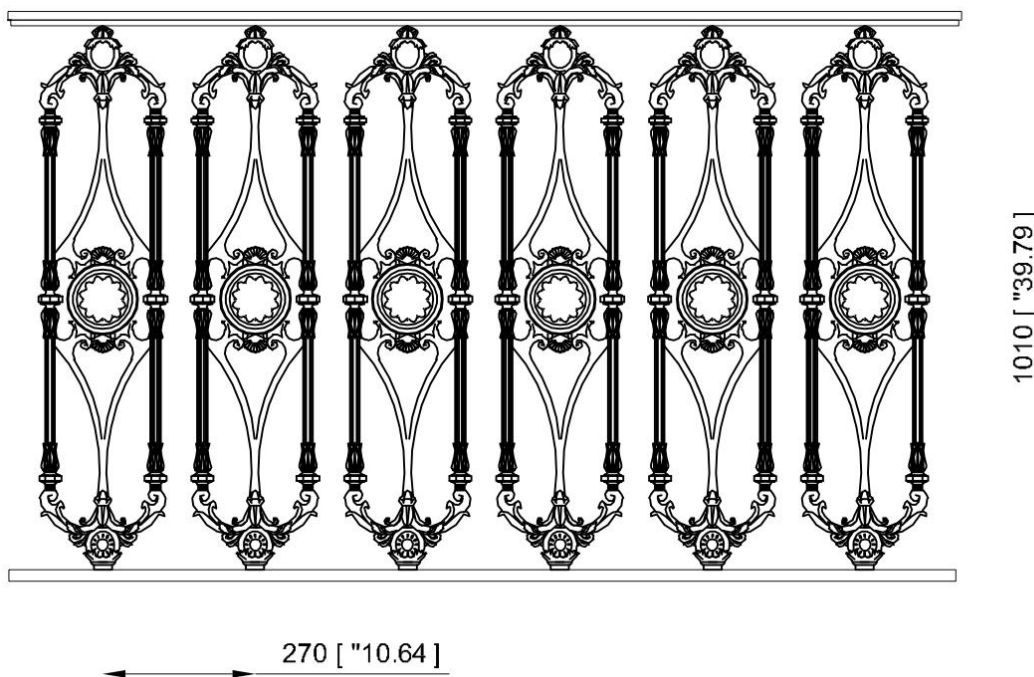

Geländerelement aus Gusseisen , montagefertig



Art.: MG 548

Rahmenhöhe : 1010 mm

Benötigte Elemente per Laufmeter: 4 Stück

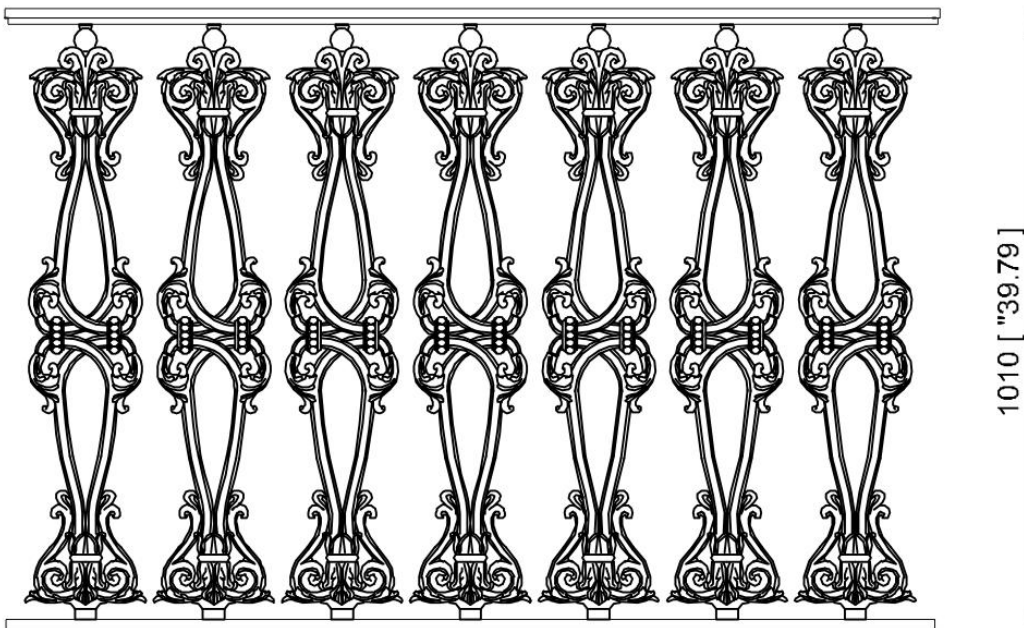

Geländerelement aus Gusseisen , montagefertig



Art.: MG549

Rahmenhöhe : 1010 mm

Benötigte Elemente per Laufmeter: 4 Stück

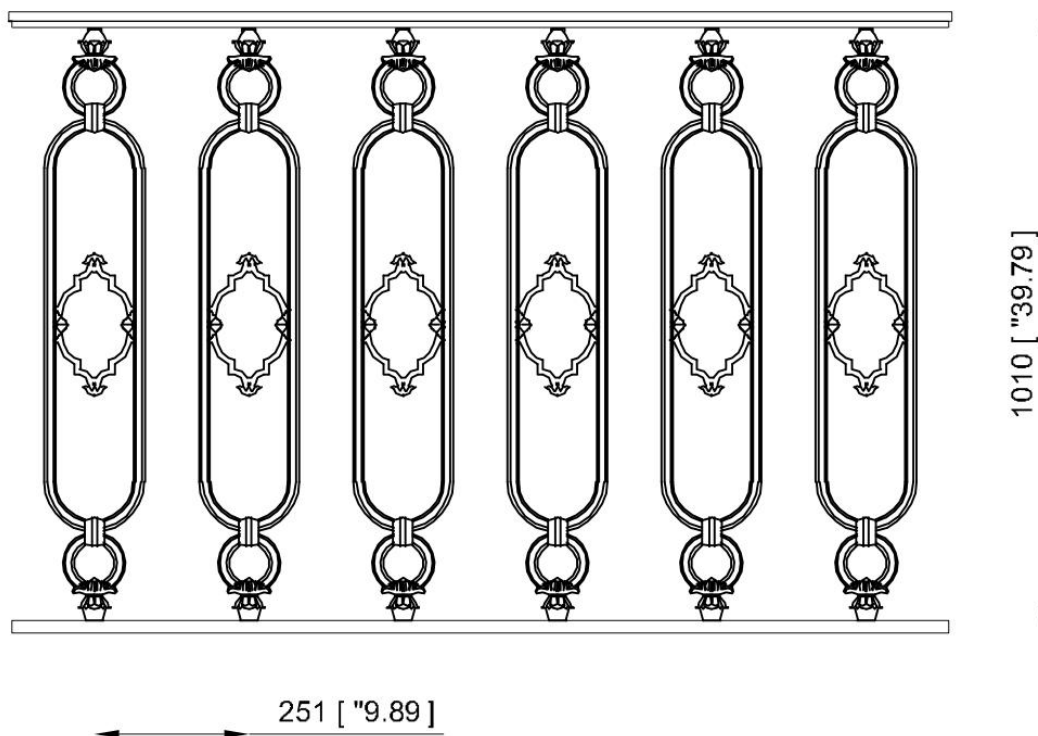

Geländerelement aus Gusseisen , montagefertig



Art.: MG555

Rahmenhöhe : 1010 mm

Benötigte Elemente per Laufmeter: 4 Stück

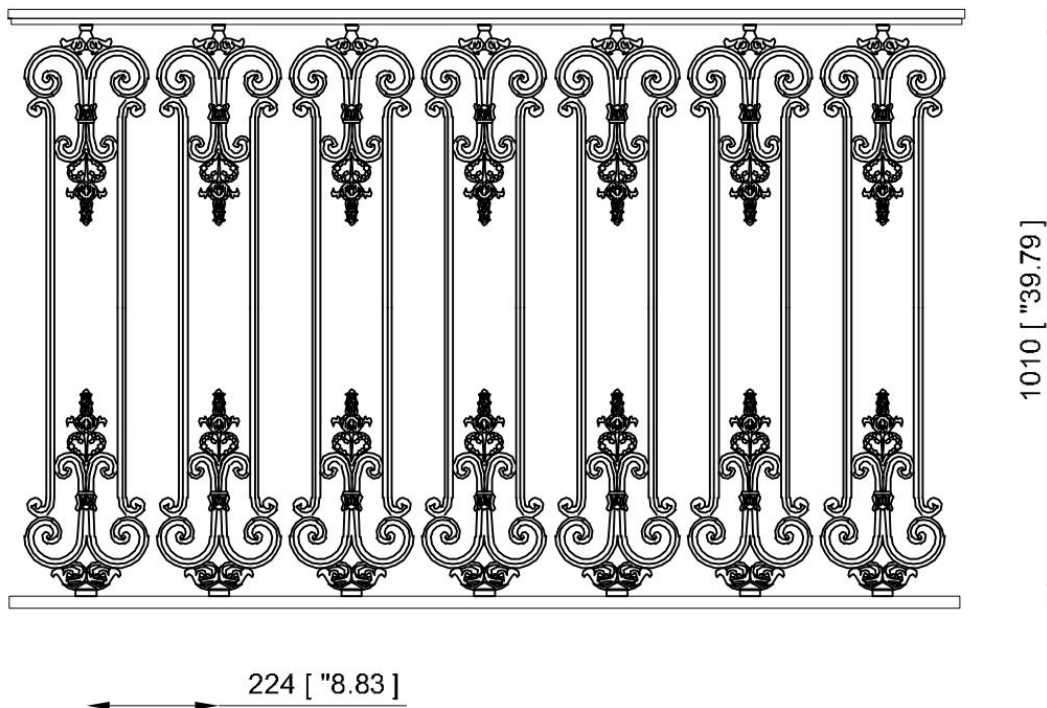

Geländerelement aus Gusseisen , montagefertig



Art.: MG566

Rahmenhöhe : 1010 mm

Benötigte Elemente per Laufmeter: 4 Stück

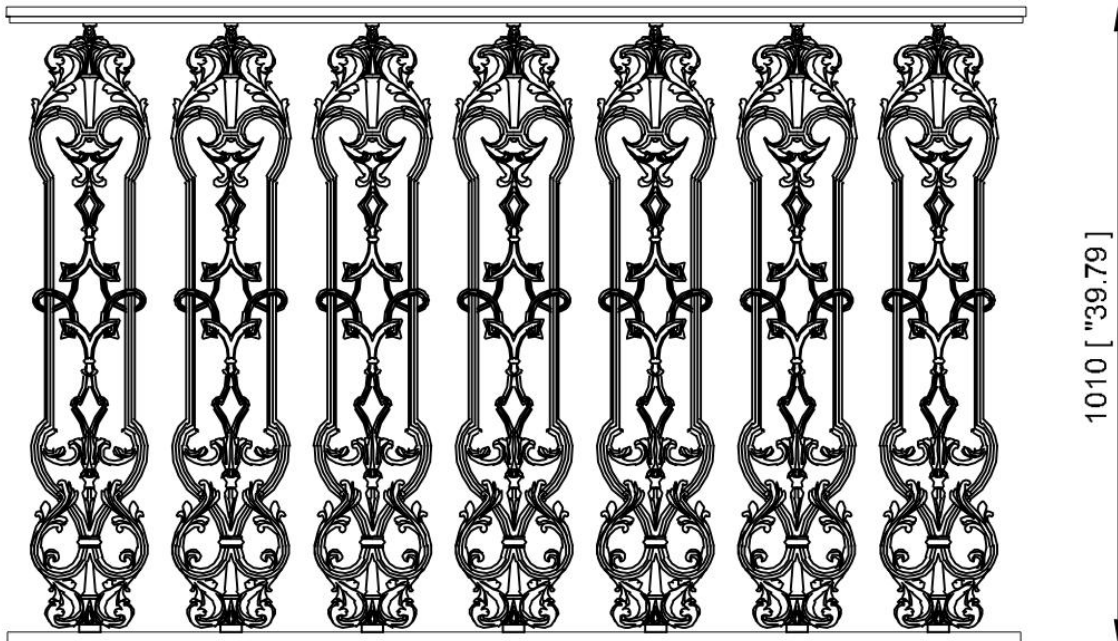

Geländerelement aus Gusseisen , montagefertig



Art.: MG508

Rahmenhöhe : 640 mm

Benötigte Elemente per Laufmeter:5 Stück

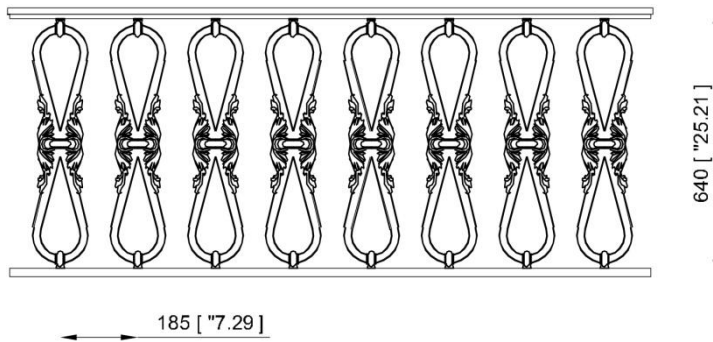

Geländerelement aus Gusseisen , montagefertig



Art.: MG551

Rahmenhöhe : 446 mm

Benötigte Elemente per Laufmeter: 5 Stück

